

Series 6500

Bell Restraint Harness for IPS O.D. (Class) PVC Pipe
 Split Serrated Restraint Rings on Both Sides of the Bell
 U.S. Patent No. 4,568,112

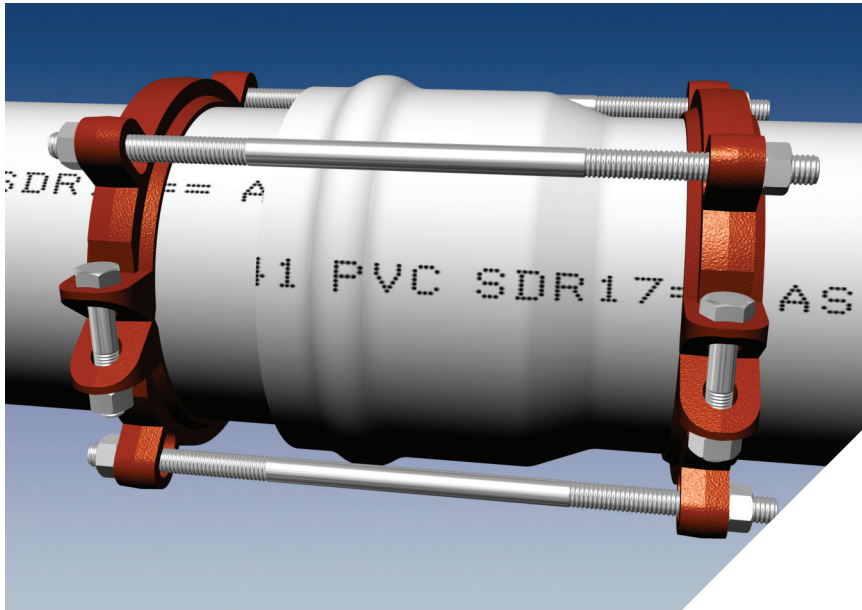

Image depicts Series 6510 on 10 inch IPS PVC Pipe.

Features and Applications:

- For use on IPS O.D. (Class) ASTM D2241 PVC Pipe Systems
- Minimum 2 to 1 Safety Factor
- **MEGA-BOND®** Restraint Coating System
For more on MEGA-BOND refer to www.ebaa.com
- Split design for ease of installation
- Constructed of ASTM A536 Ductile Iron

For use on water or wastewater pipelines subject to hydrostatic pressure and tested in accordance with either AWWA C600, C605, or ASTM D2774.

For Restraint of IPS PVC Fittings, see our **Series 7500**

Nominal Pipe Size	Series Number	Approximate Shipping Weight	Pressure Ratings (PSI)		
			SDR17	SDR21	SDR26
2	6502	5.40	250	200	160
2½	650250	5.80	250	200	160
3	6503	6.20	250	200	160
4	6504	27.40	250	200	160
6	6506	29.04	250	200	160
8	6508	43.29	250	200	160
10	6510	70.00	200	200	160
12	6512	83.60	200	200	160

NOTE: For applications or pressures not shown, please contact EBAA for assistance. This rating applies to pipe of PVC material per ASTM D2241.

Sample Specification

Restraint for ASTM D2241 pipe bells shall consist of the following: The restraint shall be manufactured of ductile iron conforming to ASTM A536. Side clamp bolts shall be of SAE J429 Grade 5 material. A split serrated ring shall be utilized behind the pipe bell. A split serrated ring shall be used to grip the pipe, and a sufficient number of bolts shall be used to connect the bell ring to the gripping ring. The restraint devices shall be coated using MEGA-BOND®. (For complete specifications on MEGA-BOND visit www.ebaa.com). The restraint shall be the Series 6500, as manufactured by EBAA Iron, Inc., or approved equal.

Packaged Items

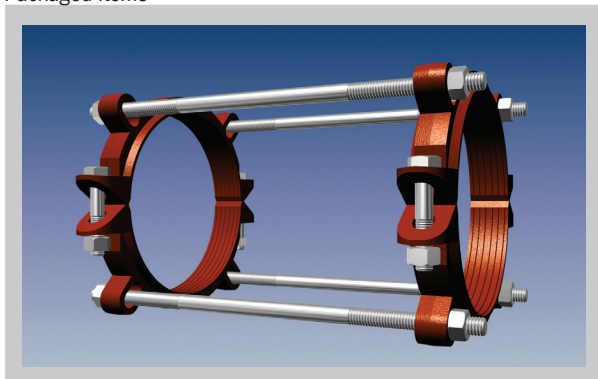

Series 6500 Submittal Reference Drawing

EBAA IRON

MADE IN USA

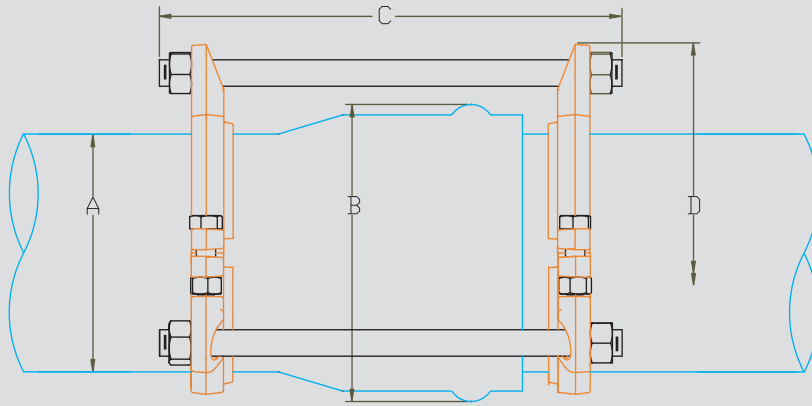

Nominal Pipe Size	Series Number	A Pipe O.D.	B Maximum Bell O.D. Cleared	C Overall Length	D Max. Restraint O.D. (Casing Clearance)	Thrust Bolt (Number - Size)
2	6502	2.38	3.56	12	5.57	2 - 5/8 x 12
2½	650250	2.88	4.08	12	6.07	2 - 5/8 x 12
3	6503	3.50	5.01	12	7.01	2 - 5/8 x 12
4	6504	4.50	6.98	18	10.00	2 - 3/4 x 18
6	6506	6.63	9.61	18	12.25	2 - 3/4 x 18
8	6508	8.63	12.50	18	15.66	2 - 3/4 x 18
10	6510	10.75	15.25	22	17.38	4 - 3/4 x 22
12	6512	12.75	17.75	22	20.00	4 - 3/4 x 22

NOTE: Dimensions are in inches and are subject to change without notice.

Installation Instructions

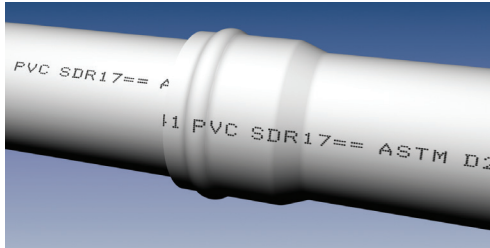

The Series 6500 is designed for restraining push-on, ASTM D2241 PVC pipe bells. It has a split, serrated restraint ring on the spigot and a split serrated ring behind the bell.

1. Assemble the push-on joint per the pipe manufacturer's instructions.

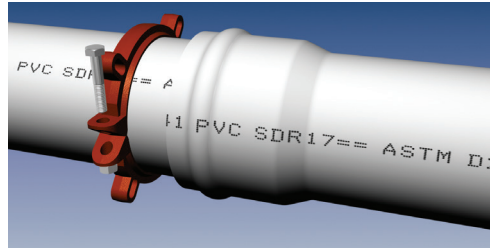

2. Install both halves of the serrated bell ring behind the bell, tapping each half into place. Make sure the complete ID of the ring is touching the pipe before installing the side bolts. Install the side bolts and tighten evenly. (40-45 ft-lbs on 2 through 3 inch, 60 ft-lbs on 4 and 6 inch, 110 ft-lbs on 8 through 12 inch)

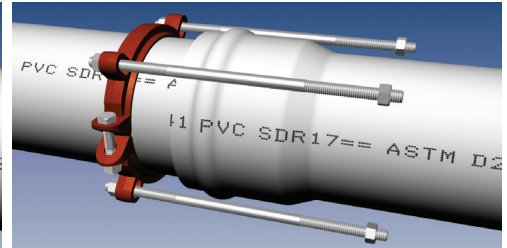

3. Remove the side bolts from the second serrated restraint ring. Use the tie bolts to determine the proper location of the restraint ring on the spigot. Allow enough room on the tie bolt to fully engage the nuts.

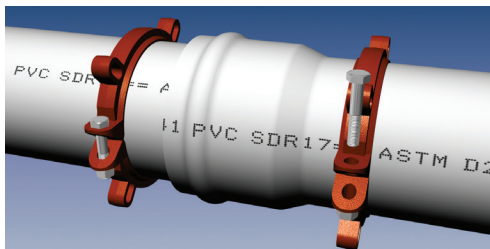

4. Install both halves of the restraint ring at the proper location, tapping each half into place. Make sure that the complete ID of the ring is touching the pipe before installing the side bolts. Install the side bolts and tighten evenly. (40-45 ft-lbs on 2 through 3 inch, 60 ft-lbs on 4 and 6 inch, 110 ft-lbs on 8 through 12 inch)

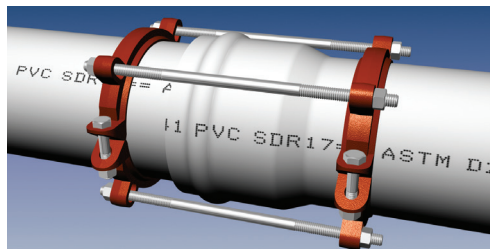

5. Place nuts on the tie bolts and tighten until they are snug. Allow enough room on the tie bolt to fully engage the nut with several threads showing. Do not tighten these bolts enough to force the spigot further into the bell of the joint.



EBAA IRON Sales, Inc.

P.O. Box 857, Eastland, TX 76448

Tel: (254) 629-1731

Fax: (254) 629-8931

(800) 433-1716 within US and Canada

contact@ebaa.com

www.ebaa.com